

STAMFORD[®]

HCI634J - Technical Data Sheet

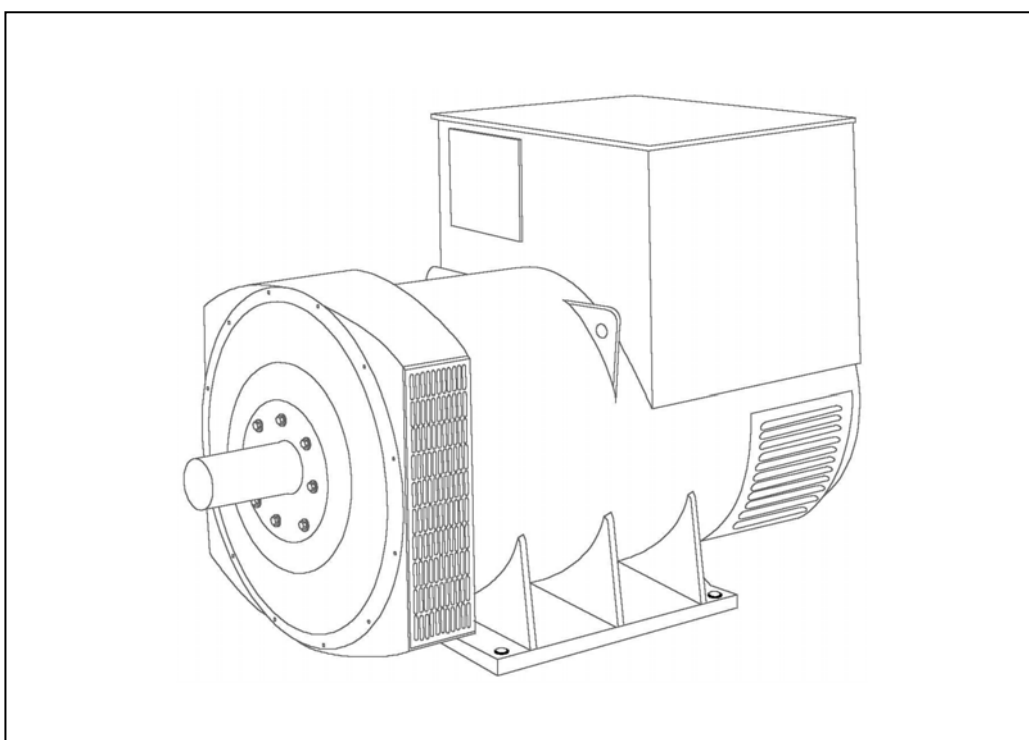

HCI634J

SPECIFICATIONS & OPTIONS

STAMFORD

STANDARDS

Newage Stamford industrial generators meet the requirements of BS EN 60034 and the relevant section of other international standards such as BS5000, VDE 0530, NEMA MG1-32, IEC34, CSA C22.2-100, AS1359.

Other standards and certifications can be considered on request.

VOLTAGE REGULATORS

MX321 AVR - STANDARD

This sophisticated Automatic Voltage Regulator (AVR) is incorporated into the Stamford Permanent Magnet Generator (PMG) system and is fitted as standard to generators of this type.

The PMG provides power via the AVR to the main exciter, giving a source of constant excitation power independent of generator output. The main exciter output is then fed to the main rotor, through a full wave bridge, protected by a surge suppressor. The AVR has in-built protection against sustained over-excitation, caused by internal or external faults. This de-excites the machine after a minimum of 5 seconds.

Over voltage protection is built-in and short circuit current level adjustments is an optional facility.

WINDINGS & ELECTRICAL PERFORMANCE

All generator stators are wound to 2/3 pitch. This eliminates triplen (3rd, 9th, 15th ...) harmonics on the voltage waveform and is found to be the optimum design for trouble-free supply of non-linear loads. The 2/3 pitch design avoids excessive neutral currents sometimes seen with higher winding pitches, when in parallel with the mains. A fully connected damper winding reduces oscillations during paralleling. This winding, with the 2/3 pitch and carefully selected pole and tooth designs, ensures very low waveform distortion.

TERMINALS & TERMINAL BOX

Standard generators feature a main stator with 6 ends brought out to the terminals, which are mounted on the frame at the non-drive end of the generator. A sheet steel terminal box contains the AVR and provides ample space for the customers' wiring and gland arrangements. It has removable panels for easy access.

SHAFT & KEYS

All generator rotors are dynamically balanced to better than BS6861:Part 1 Grade 2.5 for minimum vibration in operation. Two bearing generators are balanced with a half key.

INSULATION/IMPREGNATION

The insulation system is class 'H'.

All wound components are impregnated with materials and processes designed specifically to provide the high build required for static windings and the high mechanical strength required for rotating components.

QUALITY ASSURANCE

Generators are manufactured using production procedures having a quality assurance level to BS EN ISO 9001.

The stated voltage regulation may not be maintained in the presence of certain radio transmitted signals. Any change in performance will fall within the limits of Criteria 'B' of EN 61000-6-2:2001. At no time will the steady-state voltage regulation exceed 2%.

NB Continuous development of our products entitles us to change specification details without notice, therefore they must not be regarded as binding.

Front cover drawing typical of product range.

HCI634J

WINDING 312

CONTROL SYSTEM	SEPARATELY EXCITED BY P.M.G.	
A.V.R.	MX321	
VOLTAGE REGULATION	± 0.5 %	With 4% ENGINE GOVERNING
SUSTAINED SHORT CIRCUIT	REFER TO SHORT CIRCUIT DECREMENT CURVES (page 7)	

INSULATION SYSTEM	CLASS H	
PROTECTION	IP23	
RATED POWER FACTOR	0.8	
STATOR WINDING	DOUBLE LAYER LAP	
WINDING PITCH	TWO THIRDS	
WINDING LEADS	6	
STATOR WDG. RESISTANCE	0.002 Ohms PER PHASE AT 22°C STAR CONNECTED	
ROTOR WDG. RESISTANCE	2.09 Ohms at 22°C	
EXCITER STATOR RESISTANCE	17 Ohms at 22°C	
EXCITER ROTOR RESISTANCE	0.079 Ohms PER PHASE AT 22°C	
R.F.I. SUPPRESSION	BS EN 61000-6-2 & BS EN 61000-6-4, VDE 0875G, VDE 0875N. refer to factory for others	
WAVEFORM DISTORTION	NO LOAD < 1.5% NON-DISTORTING BALANCED LINEAR LOAD < 5.0%	
MAXIMUM OVERSPEED	2250 Rev/Min	
BEARING DRIVE END	BALL. 6224 (ISO)	
BEARING NON-DRIVE END	BALL. 6317 (ISO)	

	1 BEARING				2 BEARING			
WEIGHT COMP. GENERATOR	2279 kg				2300 kg			
WEIGHT WOUND STATOR	1120 kg				1120 kg			
WEIGHT WOUND ROTOR	962 kg				916 kg			
WR ² INERTIA	22.9287 kgm ²				22.3814 kgm ²			
SHIPPING WEIGHTS in a crate	2328kg				2329kg			
PACKING CRATE SIZE	183 x 92 x 140(cm)				183 x 92 x 140(cm)			
	50 Hz				60 Hz			
TELEPHONE INTERFERENCE	THF<2%				TIF<50			
COOLING AIR	1.614 m ³ /sec 3420 cfm				1.961 m ³ /sec 4156 cfm			
VOLTAGE STAR	380/220	400/231	415/240	440/254	416/240	440/254	460/266	480/277
VOLTAGE DELTA	220	230	240	254	240	254	266	277
kVA BASE RATING FOR REACTANCE VALUES	1000	1000	1000	1000	1150	1200	1250	1300
X _d DIR. AXIS SYNCHRONOUS	3.02	2.73	2.54	2.26	3.49	3.25	3.10	2.96
X' _d DIR. AXIS TRANSIENT	0.24	0.22	0.20	0.18	0.28	0.26	0.25	0.24
X'' _d DIR. AXIS SUBTRANSIENT	0.17	0.15	0.14	0.12	0.19	0.18	0.17	0.16
X _q QUAD. AXIS REACTANCE	1.78	1.61	1.50	1.33	2.05	1.91	1.82	1.74
X'' _q QUAD. AXIS SUBTRANSIENT	0.21	0.19	0.18	0.16	0.25	0.23	0.22	0.21
X _L LEAKAGE REACTANCE	0.09	0.08	0.08	0.07	0.10	0.10	0.09	0.09
X ₂ NEGATIVE SEQUENCE	0.21	0.19	0.18	0.16	0.25	0.23	0.22	0.21
X ₀ ZERO SEQUENCE	0.03	0.02	0.02	0.02	0.03	0.03	0.03	0.03

REACTANCES ARE SATURATED

VALUES ARE PER UNIT AT RATING AND VOLTAGE INDICATED

T' _d TRANSIENT TIME CONST.	0.185
T'' _d SUB-TRANSTIME CONST.	0.025
T' _{do} O.C. FIELD TIME CONST.	3.03
T _a ARMATURE TIME CONST.	0.046
SHORT CIRCUIT RATIO	1/X _d

50
Hz

HCI634J
Winding 312

STAMFORD

THREE PHASE EFFICIENCY CURVES

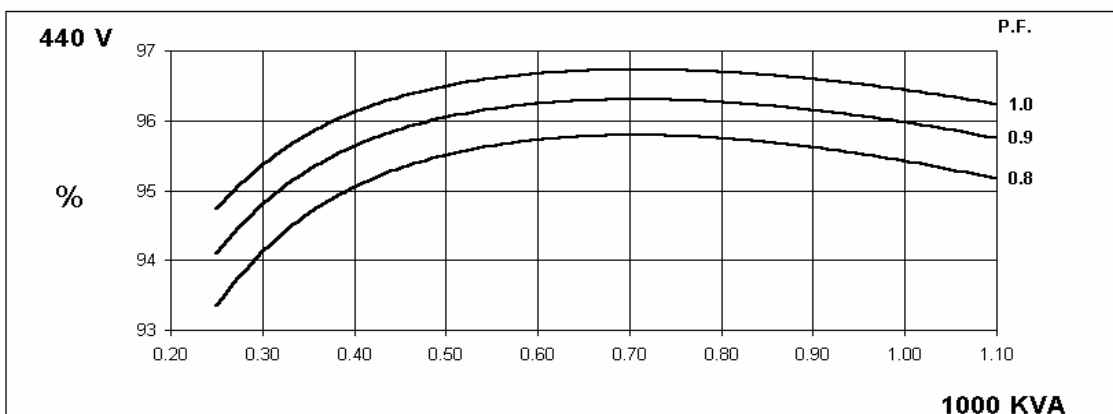
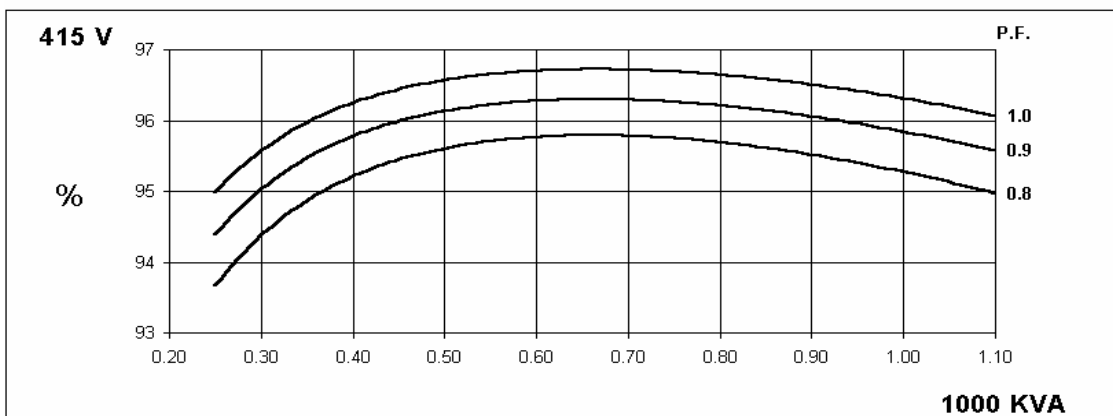
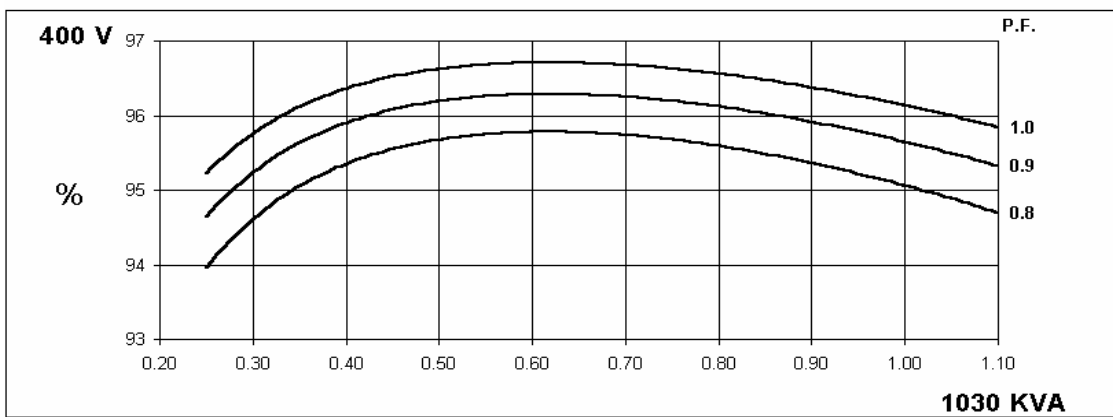
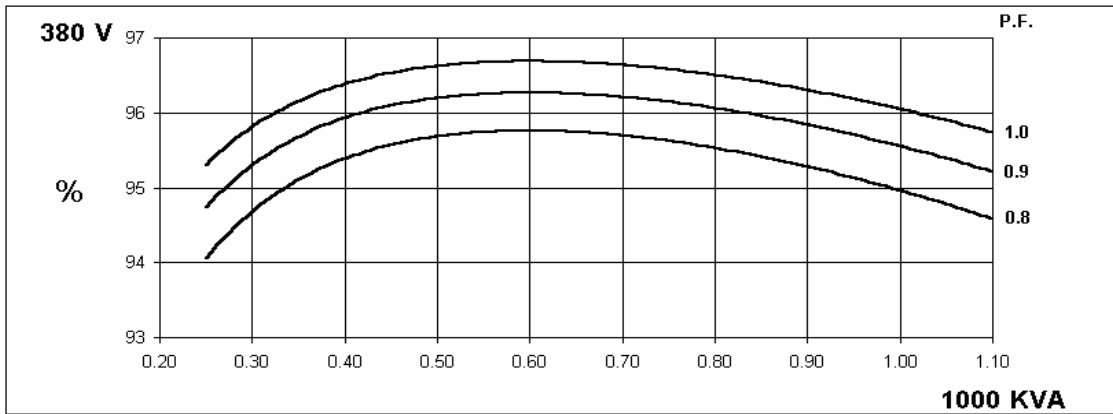

60
Hz

HCI634J
Winding 312

STAMFORD

THREE PHASE EFFICIENCY CURVES

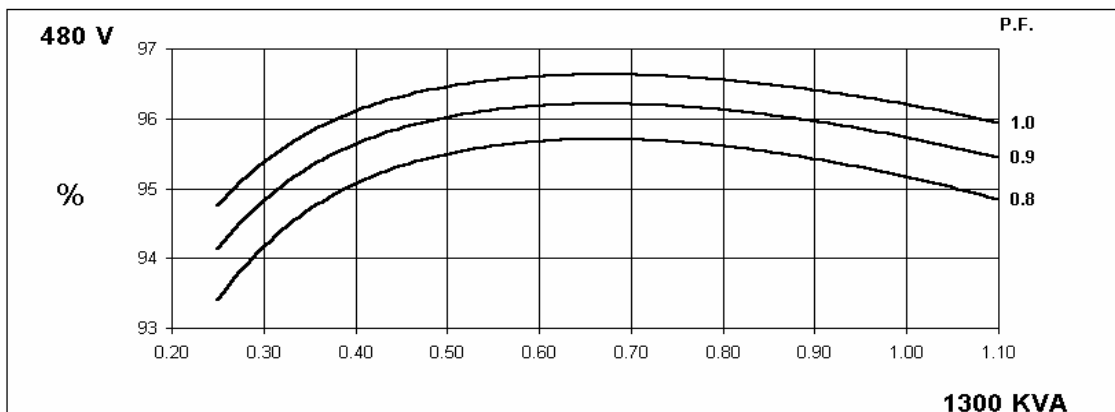
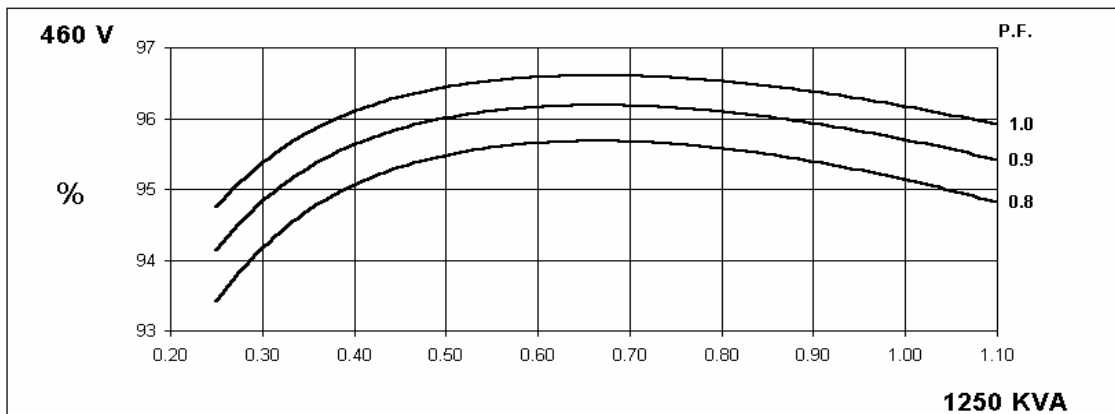
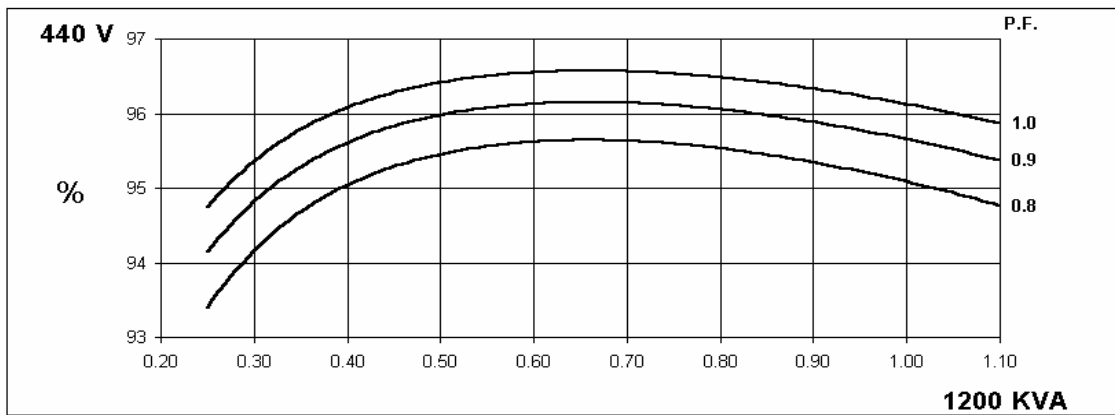
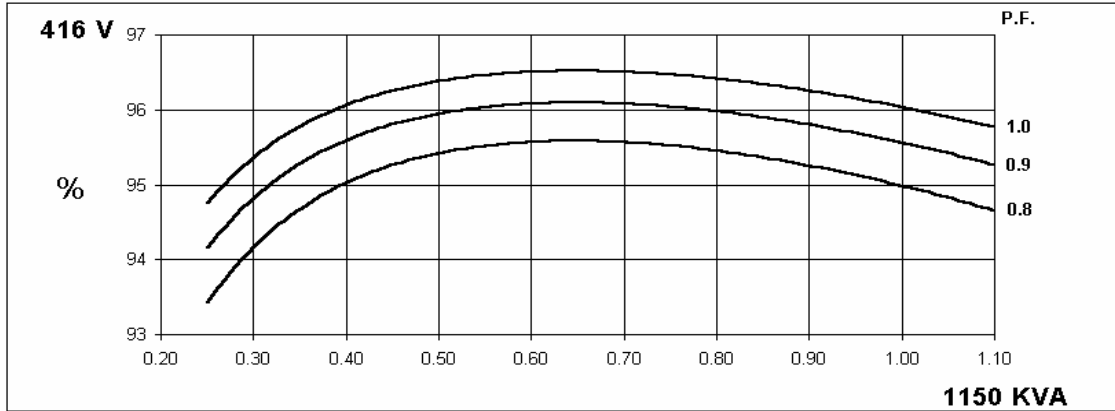

HCI634J
Winding 312

STAMFORD

Locked Rotor Motor Starting Curve

50
Hz

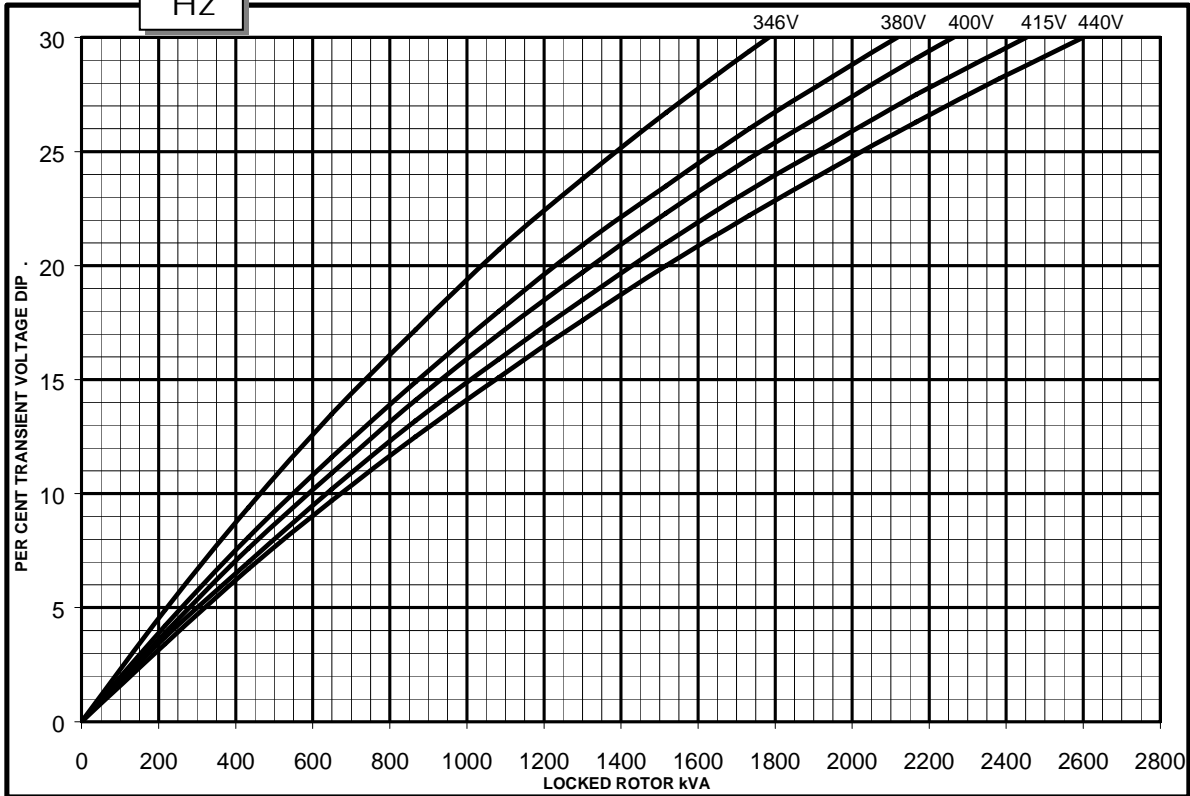

60
Hz

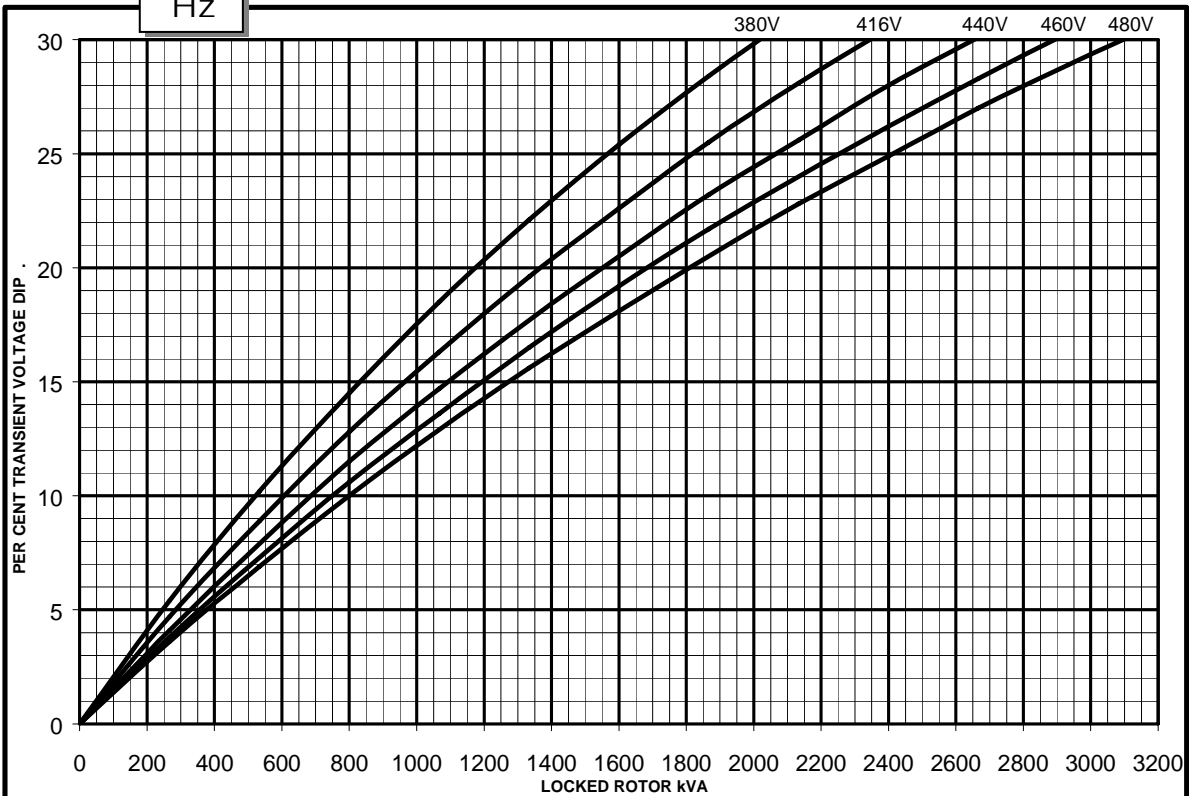

**Three-phase Short Circuit Decrement Curve. No-load Excitation at Rated Speed
Based on star (wye) connection.**

50
Hz

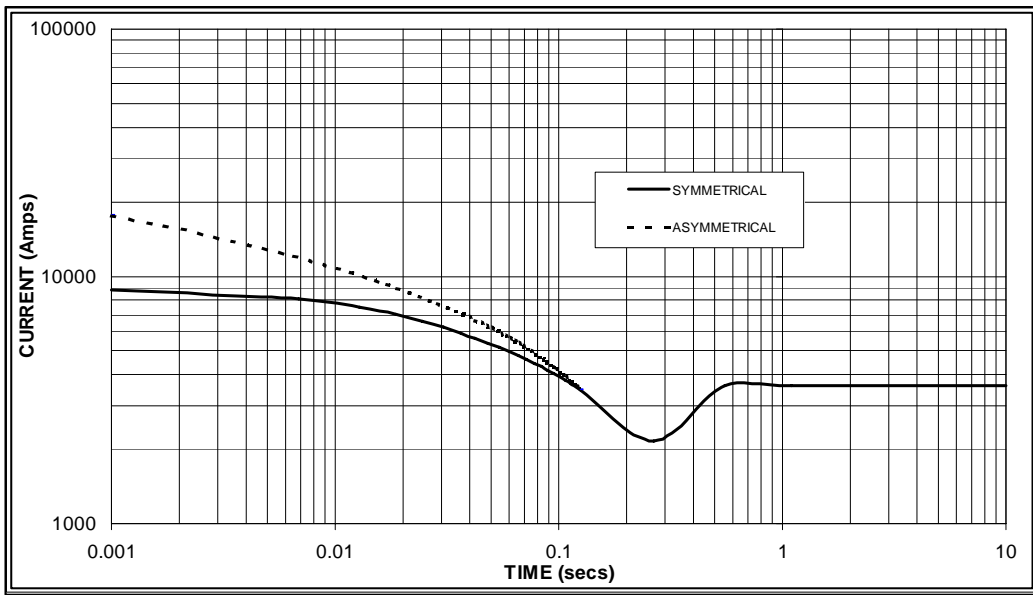

Sustained Short Circuit = 3,600 Amps

60
Hz

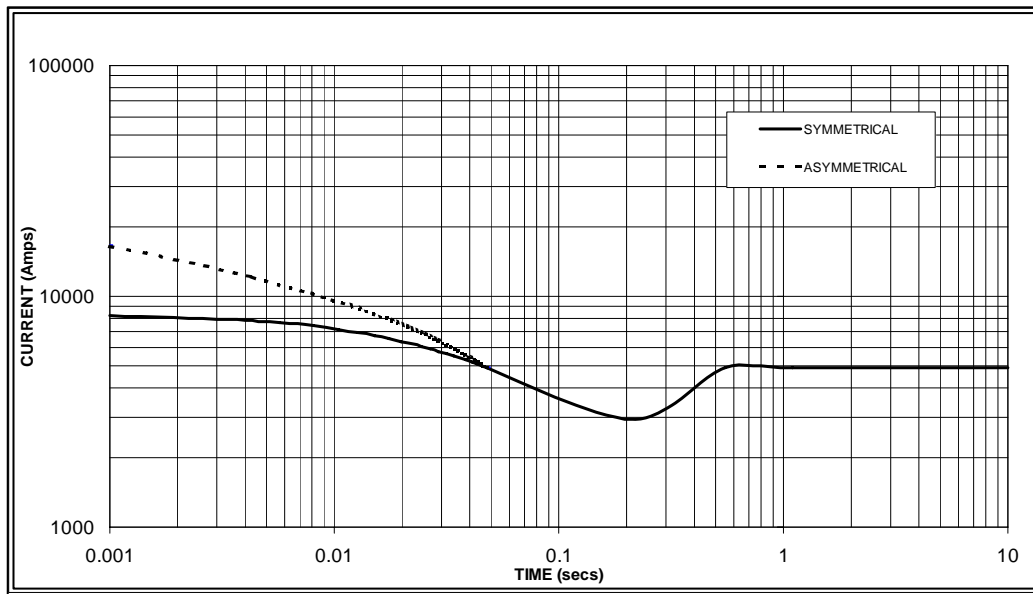

Sustained Short Circuit = 4,900 Amps

Note 1

The following multiplication factors should be used to adjust the values from curve between time 0.001 seconds and the minimum current point in respect of nominal operating voltage :

50Hz		60Hz	
Voltage	Factor	Voltage	Factor
380v	X 1.00	416v	x 1.00
400v	X 1.07	440v	x 1.06
415v	X 1.12	460v	x 1.12
440v	X 1.18	480v	x 1.17

The sustained current value is constant irrespective of voltage level

Note 2

The following multiplication factor should be used to convert the values calculated in accordance with NOTE 1 to those applicable to the various types of short circuit :

	3-phase	2-phase L-L	1-phase L-N
Instantaneous	x 1.00	x 0.87	x 1.30
Minimum	x 1.00	x 1.80	x 3.20
Sustained	x 1.00	x 1.50	x 2.50
Max. sustained duration	10 sec.	5 sec.	2 sec.

All other times are unchanged

Note 3

Curves are drawn for Star (Wye) connected machines.
For Delta connection multiply the Curve current value by 1.732

HCI634J

Winding 312 0.8 Power Factor

RATINGS

Class - Temp Rise	Cont. F - 105/40°C				Cont. H - 125/40°C				Standby - 150/40°C				Standby - 163/27°C				
50Hz	Star (V)	380	400	415	440	380	400	415	440	380	400	415	440	380	400	415	440
	Delta (V)	220	230	240	254	220	230	240	254	220	230	240	254	220	230	240	254
	kVA	900	927	900	900	1000	1030	1000	1000	1060	1070	1060	1060	1100	1110	1100	1100
	kW	720	742	720	720	800	824	800	800	848	856	848	848	880	888	880	880
	Efficiency (%)	95.3	95.4	95.5	95.6	95.0	95.1	95.3	95.4	94.7	94.9	95.1	95.3	94.6	94.8	95.0	95.2
	kW Input	756	777	754	753	842	866	839	839	895	902	892	890	930	937	926	924

60Hz	Star (V)	416	440	460	480	416	440	460	480	416	440	460	480	416	440	460	480
	Delta (V)	240	254	266	277	240	254	266	277	240	254	266	277	240	254	266	277
	kVA	1063	1100	1150	1188	1150	1200	1250	1300	1206	1250	1300	1350	1250	1300	1350	1400
	kW	850	880	920	950	920	960	1000	1040	965	1000	1040	1080	1000	1040	1080	1120
	Efficiency (%)	95.2	95.3	95.3	95.4	95.0	95.1	95.1	95.2	94.8	95.0	95.0	95.1	94.7	94.8	94.9	94.9
	kW Input	893	923	965	996	968	1009	1052	1092	1018	1053	1095	1136	1056	1097	1138	1180

DIMENSIONS

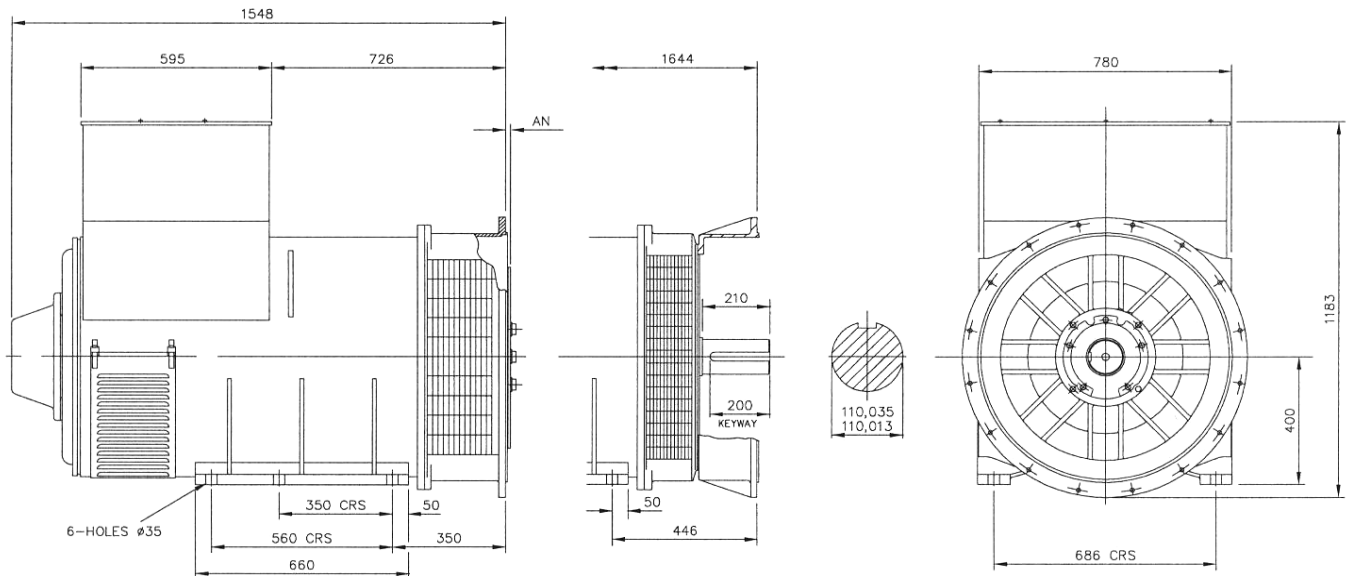

SAE	14	18	21	24
AN	25.4	15.87	0	0